

nexusEazy

FILTRATION system

200 / 300

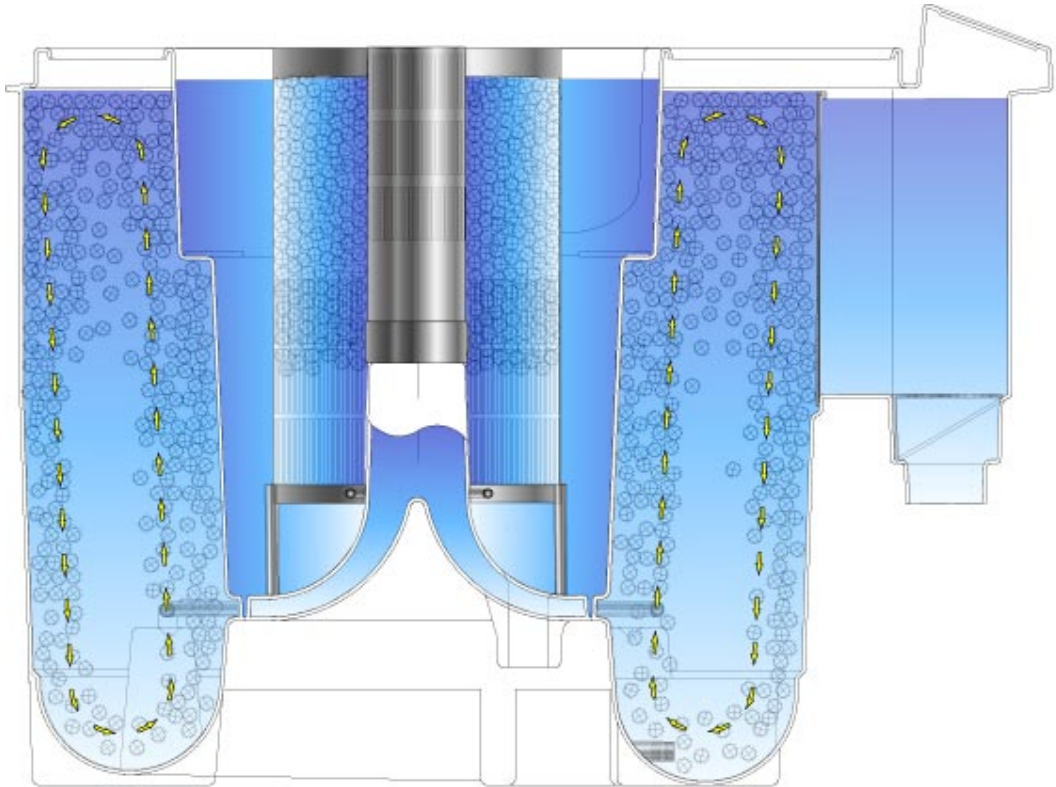

Installation & Operating Instructions

*Note: Do not attempt to operate this unit
before reading the manual thoroughly*

Manufactured by Evolution Aqua Ltd.

Evolution House

Kellett Close

Wigan WN5 0LP

Tel: +44 (0) 1942 216554

Fax: +44 (0) 1942 216562

Web: www.evolutionaqua.com

E-mail: info@evolutionaqua.com



Nexus Eazy Specifications and Flow Rates

Follow your relevant section carefully and your filter will perform correctly providing a perfect environment for your Koi. One of the factors that can have a significant influence on the general parameters of our ponds is turn over rate. This is the time that it takes for the total volume of the pond to pass through the filter system once. On Nexus ponds a turn over of every 2 to 3 hours is found to be best.

Thank you for purchasing your Nexus Eazy™ filter. We are sure you will be delighted with its performance. You should have already decided whether your filter system will be pump or gravity fed. Please go to the relevant section and read thoroughly before installation.

The Nexus Eazy filtration unit has been designed on the principles of minimum maintenance, high performance and a compact foot print. This design delivers optimum water quality by using the Kaldnes Moving Bed™ process.

Basic Operation Nexus:

This section briefly explains the basic operation of the Nexus filtration system. Water is delivered to the inlet of the filter and enters chamber A (see fig. 15). This chamber is the main mechanical stage of the filter. All of the solids and debris are stopped in chamber A and are sumped to waste via a 1.5 inch ball valve provided. The water then passes to chamber B containing the Kaldnes Moving Bed where the biological filtration takes place. The air ring at the base of chamber B constantly agitates the media. Chambers C & D are empty and allow the clean water to return to the pond.

Basic Operation Eazy :

The Eazy™ is a stainless steel vessel containing a volume of static K1 media which is located within the centre chamber of the Nexus. Water enters the centre chamber and then enters the 'Eazy' via slots in the lower half of the unit. This results in a downward flow causing many of the larger solids to settle out prior to entering the Eazy. The size of the slots will not allow large mechanical waste to enter the cylinder thus acting as a first stage mechanical filtration. The water then passes through the static K1 media, utilising up and side flow and this process causes the fine solids to become entrapped. The mechanically clean water then passes to the outside chamber of the Nexus where the Kaldnes moving bed™ is located for biological treatment, prior to being returned to the pond.

Nexus Eazy 200

Max flow rate:	10,000 litres/hr 2,200 UK or 2,640 US gallons/hr
Max pond size:	18,000 litres 4,000 UK or 4,800 US gallons
Kaldnes K1:	50 litres (for bio stage – max 150 litres possible) 30 litres (for Eazy – max 30 litres possible)

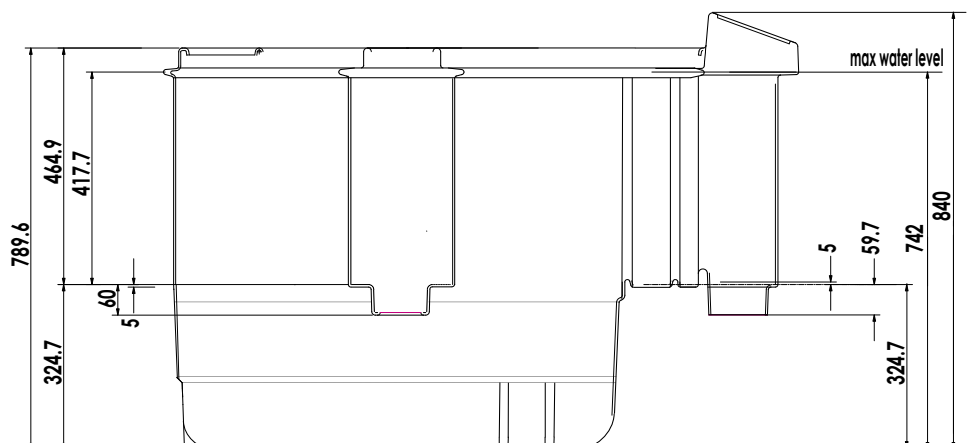
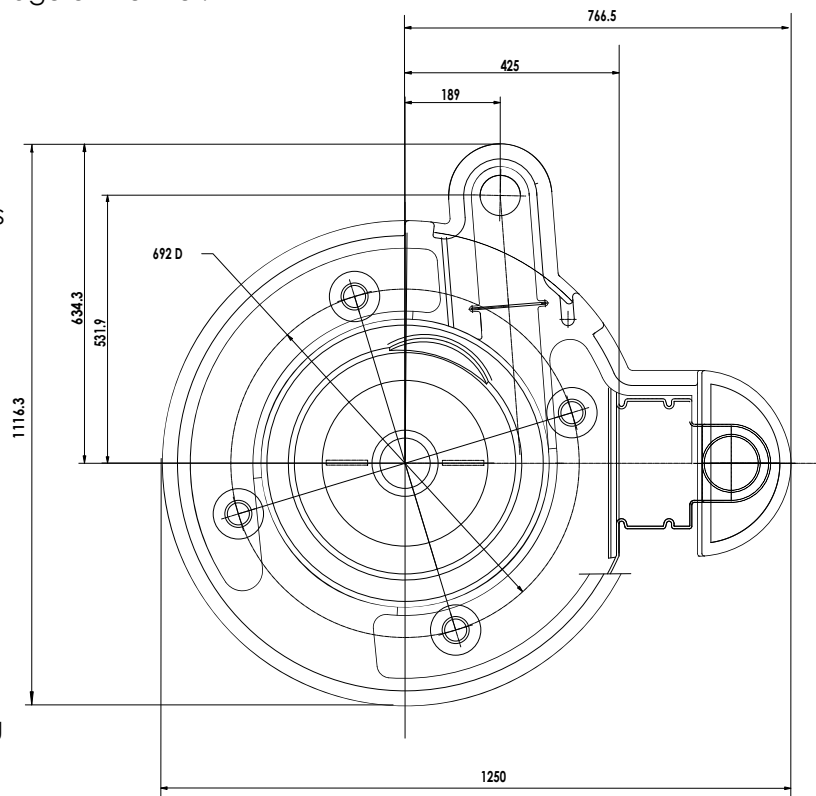

Nexus Eazy 300

Max flow rate: 15,000 litres/hr 3,300 UK or 3,900 US gallons/hr
Max pond size: 34,000 litres 7,500 UK or 9,000 US gallons
Kaldnes K1: 100 litres (for bio stage – max 200 litres possible)
 45 litres (for Eazy – **max 45 litres** possible)



Fig. 1

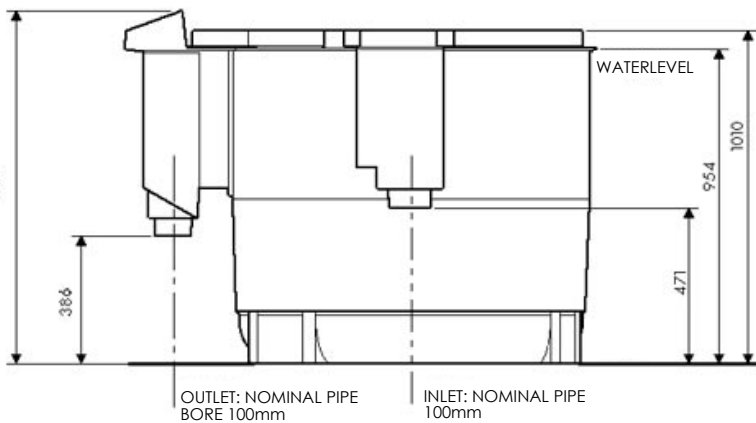
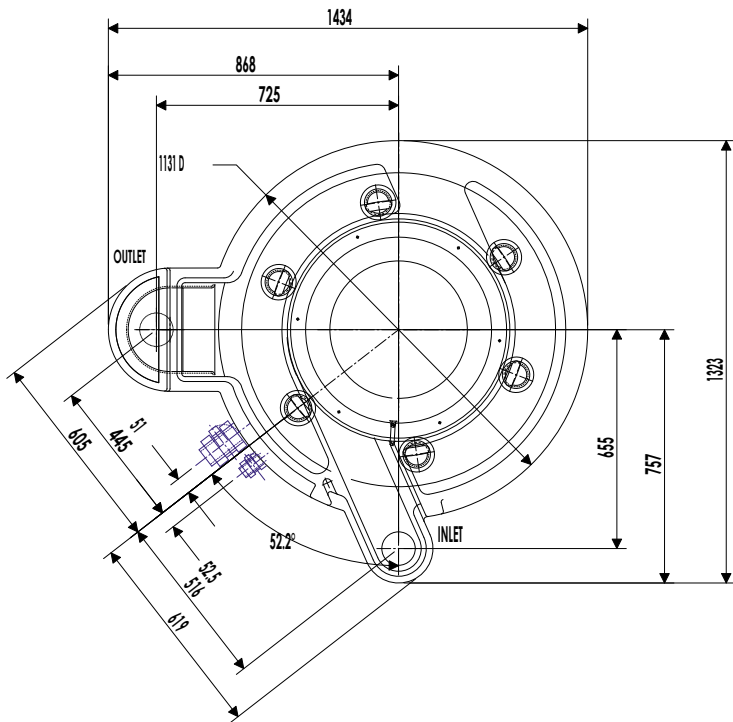

On opening your Nexus you will find the following:

- Fig.1 Nexus 200 or 300 main body
- Fig.2 Stainless steel Eazy vessel, comes fitted
- Fig.3 Stainless steel centre pipe, comes fitted
- Fig.4 Kaldnes K1 30 litres, for the Eazy 200, 45 litres for the Eazy 300
- Fig.5 Nexus isolation pipe, used during cleaning.



Fig. 2



Fig. 3



Fig. 4



Fig. 5



Fig. 6



Fig. 7



Fig. 8



Fig. 9



Fig. 10



Fig. 11

- Fig.6 Kaldnes K1 for bio chamber Nexus 200 = 50 litres Nexus 300 = 100 litres.
- Fig.7 Inlet plate (Gravity fed only).
- Fig.8 Weir plate, comes fitted (Nexus 200 pump fed only).
- Fig.9 Standpipe (Nexus 300 pump fed only).
- Fig.10 1.5 inch ball valve, for pressure inlet pump fed only.
- Fig.11 Two rubber connecting adapters, fitted

Pump Fed Systems

The nexus filtration system can be used in two ways pump or gravity fed (fig.12 –pump fed)

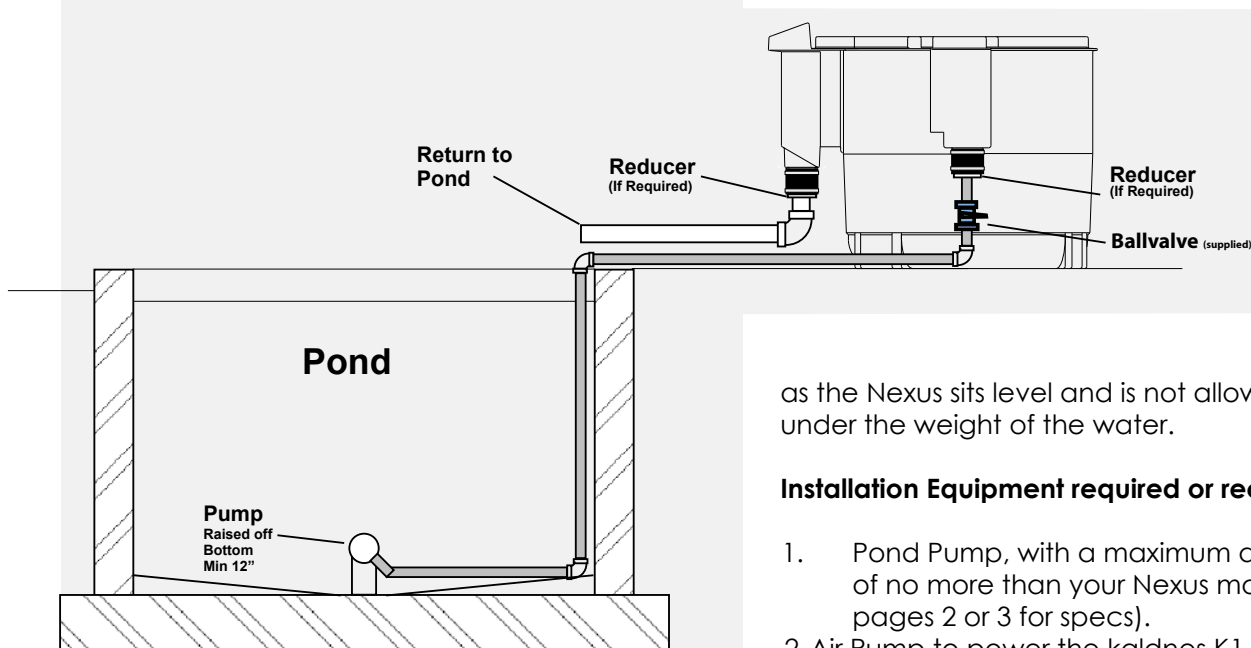

Fig. 12

Important: you must raise your pump off the pond floor. It is incorrect practice to place a pond pump on the base of any pond as failure in the filtration system. Pipe work or connectors could lead to complete drainage of the pond. Therefore leave a sufficient gap (min. 12") for your Koi

Gravity Fed Systems

In fig 13 you can see a typical set-up of a gravity system.

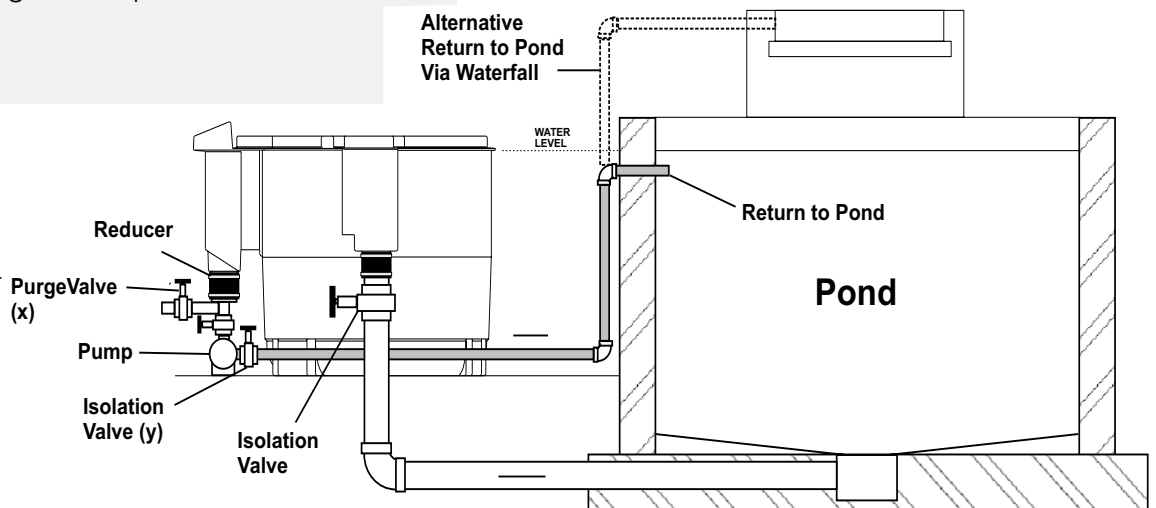

Fig. 13

Installation Section Pump + Gravity Fed

We recommend that you read all the following sections, then select the appropriate installation section.

- Preparation
- Installation Equipment
- Pump Fed installation Section

Preparation

A base level solid ground is required. It should be a minimum of 1.2m x 1.0m, to allow easy access to valves and for maintenance purposes.

Important:

The Nexus filter needs to be equally supported on the three pairs of feet which are located under the vessel. This is to prevent possible distortion when it is full of water.

The best option for this would be a level 100 mm thick concrete plinth. Although decking, paving slabs or gravel would be sufficient as long

as the Nexus sits level and is not allowed to deflect under the weight of the water.

Installation Equipment required or recommended:

1. Pond Pump, with a maximum actual flow rate of no more than your Nexus model allows (see pages 2 or 3 for specs).
2. Air Pump to power the kaldnes K1 Moving Bed, see specifications for size of pump required on page 6.
3. Length of hose or braided pipe (10 mm inner diameter) to connect the air pump to the already positioned/supplied air ring.

4. Ensure that the air pump is sited well above water level to prevent water siphoning back from the filter into the pump due to power cuts or maintenance shut downs.
5. Pipe work from the unit's waste valves to the intended discharge point. This can be rigid pipe work to a simple flexible hose.
6. A PVC reducer to connect your circulating pump or pipe to the rubber connector supplied with your Nexus (the size of which will depend on your choice of pipe work to and from the pond itself)
7. Care must be taken when connecting the waste valves (fig. 14 for the suggested method) to your chosen point of discharge valve.



Fig. 14

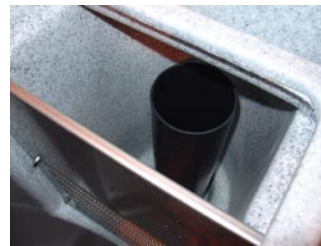

Fig. 16

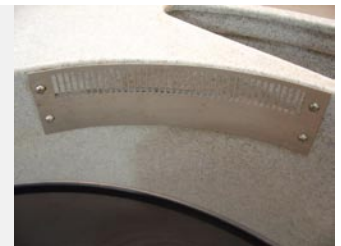

Fig. 17



Fig. 18



Fig. 19

On the 300, the level is maintained with the exit standpipe in the outlet (Fig.16). An overflow grill is cut out of the central chamber wall for added protection(Fig.17). In the 200, a weir plate (Fig.18) sets the Nexus water level and the overflow is built into the wall between the two chambers, with a section moulded at a lower height (Fig.19).

NB. NON UK CUSTOMERS PLEASE NOTE: if you are pump fed, you will receive the weir (200) and standpipe (300) loose and they need to be inserted as shown. The weir is simply dropped into place. To insert the pipe, the top two bolts and locknuts are removed from the stainless steel outlet plate. Gently pull the plate forward and firmly push the standpipe in place. Replace the nuts and washer. IF THIS PIPE IS NOT FITTED, THE WATER LEVEL IN THE BIOLOGICAL CHAMBER WILL BE TOO LOW FOR THE FULL USE OF THE BIO MEDIA AND THE EAZY !

Pump Fed Installation Section 200 + 300

Important: Essential First Action

In any pump fed installation, the first step is to make sure that the water level weir plate/standpipe is in place (Fig. 15 or Fig.16).

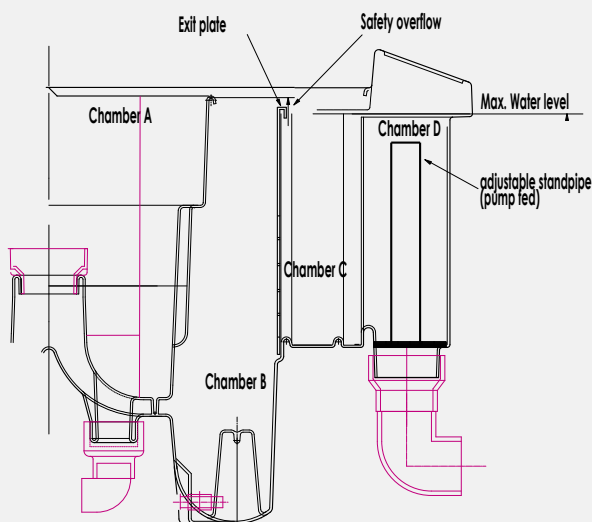

Fig. 15

THIS MUST BE DONE BEFORE ANY ADDITIONAL INSTALLATION WORK IS CARRIED OUT.

Figure 12 illustrates a typical pump fed installation. When selecting the position of your Nexus Eazy filter, carefully consider the following factors:

The unit can be any height above the surface water level, allowing adequate gravity return to the pond (subject to the maximum performance of your chosen pump) However, care needs to be taken that the top of the Nexus is at least 500 mm higher than the discharge point of the gravity return pipe into the pond (assuming that the gravity return pipe discharges above the surface of the pond. If the gravity return pipe discharges below the surface of the pond. Please allow 50 mm from the exit of the Nexus to the surface of the pond).

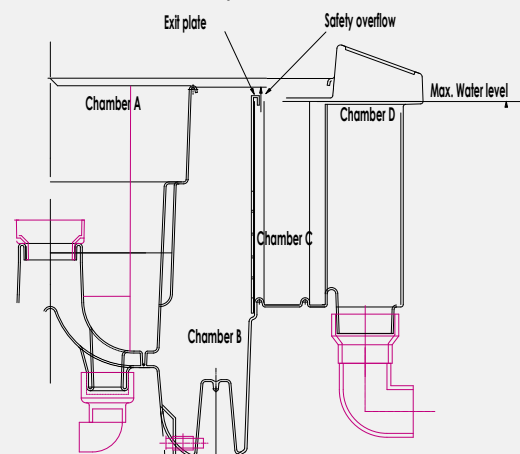

Fig. 20 gravity version

The gravity return pipe work from the exit point of the Nexus to the pond needs to be a minimum of 75 mm (external diameter) and should have no restrictions. Great care should be taken to ensure that no air locks are created within the gravity return pipe work. The pipe work from the pond pump to the inlet of the Nexus will need to be connected to the rubber 50 mm connecting adapter that is fitted to the inlet of the Nexus. A PVC reducer may be required, the size of which depends on the size of the pipe you have chosen to connect the pump to the Nexus. The 75 mm (minimum) gravity return pipe work will need to be connected to the rubber adapter on the exit point of the Nexus. This pipe is then extended / returned to the pond or waterfall as required.

Gravity Fed Installation Section 200 + 300

Once you have positioned the Nexus, please connect the pipe work in accordance with your requirements.

Recommendations:

The rubber 110 mm / 4" boot supplied will go onto the inlet point, connecting the Nexus to the pond after the recommended isolating valve has been fitted between the bottom drain and your Nexus. The other rubber boot (supplied) will then fit onto the outlet side of the Nexus to connect the outlet to your circulating pump. A PVC adapter / reducer may be required.

Air Pump Installation Pump + Gravity

Now that you have your Nexus installed, we need to get the Kaldnes installed and the air pump attached to circulate it. This will be circulated permanently in the outer biological chamber when your system is running and for cleaning only in the central chamber when maintaining the Eazy (Fig.21). Your choice of air pump will depend on how much Kaldnes you have in your biological chamber...see table. The

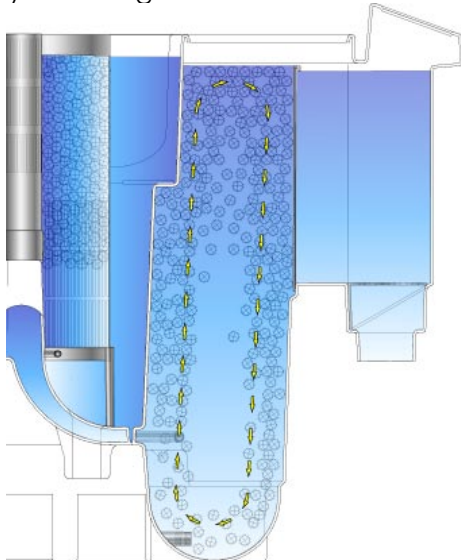

Fig. 21

size of air pump required will depend on the amount of K1 media used.

Air Pump Size	Capacity of K1 media
15/20 litres per min	50 litres of K1 media.
40 litres per min	100 litres of K1 media.
80 litres per min	100-150 litres of K1 media.

The air pump is connected using a pipe (10 mm inner diameter) to the air ring inlet which is positioned on the outside of the Nexus. It is recommended to position the air pump higher than the surface water level in the Nexus to prevent water flowing back into the air pump when it is switched off (see fig. 22).

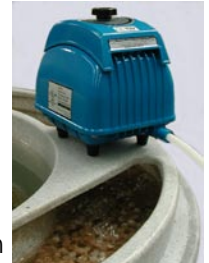

Fig. 22

Getting Started

Empty your correct amount of K1 into the empty outer biological stage. Fill your Eazy with its appropriate amount (Fig.4). Once the nexus is plumbed in, the pump is fitted and the media is in, it is ready to be started. As with anything, maintenance is an individual and personal thing. Cleaning and maintaining the Nexus will depend on flow rate, feed, stocking, blanket weed etc. A summer pond after a blanket weed treatment will obviously need more care than a December unheated pond with no food fed. Be aware that any movement of the Eazy K1 will disturb fines back into the pond. The biome-dia k1 is zero maintenance. The cleaning regimes for both pump and gravity installations are listed below. When all the connections have been made the Nexus filter may be filled from the pond and the air pump switched on. The K1 media will not attain neutral buoyancy completely to begin with. Most of the media floats, which is normal. In existing mature pond water the media may start to circulate fully in as little as 2 - 3 hours. In a newly filled and stocked pond this full movement may take up to a week to occur. Either way a constant and even circulation should be achieved throughout the chamber. (For more information about this please read the Kaldnes K1 media section).

System running and maintenance :

To achieve optimum water clarity we recommend that the "Eazy" be air backwashed and purged on a regular basis. The frequency of cleaning will depend on the loading of the pond. The longer the filter is left undisturbed the finer the filtration will become. However the filter must be purged regularly to avoid circulation pump starvation on a gravity system or chamber overflow on a pump fed system.

Cleaning Gravity Procedure

- 1 Stop the circulation pump.
- 2 Wait a short a period of time so as to allow the water levels within the Nexus to stabilise.

- 3 Close off the feed to the biological chamber by inserting the isolation pipe into the centre of the "Eazy", ensuring that the rubber flange engages within the Nexus centre spigot (Fig.23).



Fig. 23

- 4 Close the inlet to the Nexus by using the inlet slide-plate supplied with your Nexus. You should now have isolated your "Eazy" from the system (Fig.24).



Fig. 24

- 5 Open the air valve until the Kaldnes in the "Eazy" is boiling.



Fig. 25

- 6 After the "Eazy" has been boiling for a minimum of one minute, open the valve to waste drain from the central Nexus chamber.
- 7 Once central chamber has drained, close waste valve.
- 8 Remove the Isolation pipe
- 9 Close the airvalve.
- 10 Remove the Nexus inlet slide-plate allowing the nexus to refill.
- 11 Restart the circulation pump.

Cleaning Pump Procedure

- 1 Close single union ball valve on inlet pressure line (supplied) (Fig.26).
- 2 Close off the feed to the biological chamber by inserting the Isolation pipe into the centre of the "Eazy", ensuring that the rubber flange engages within the Nexus centre spigot.
- 3 Re-open inlet valve until the water level within the Nexus central chamber is level with the overflow, close inlet valve. It is essential that this water level is maintained to allow efficient cleaning.
- 4 Switch off the pond pump.
- 5 Open the air valve until the Kaldnes in the "Eazy" is boiling.
- 6 After the "Eazy" has been boiling for a minimum of one minute, open the valve to waste drain from the central Nexus chamber.
- 7 Once central chamber has drained, close waste valve.

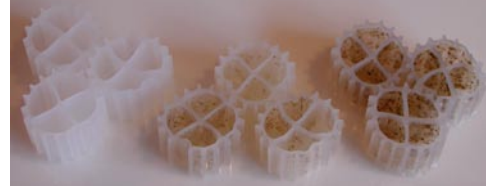

Fig. 26

- 8 Remove the Isolation pipe
- 9 Close the airvalve.
- 10 Open inlet valve.
- 11 Restart the pond pump.

Kaldnes Moving Bed™ Process

Kaldnes Moving Bed™ process, has been scientifically tried and tested in fish farming and waste treatment for over 10 years.



Illustrated above are the different stages of maturity that will be experience during the first few months.

Developed by Professor Halvard Ødergard at Trondheim University of Science and Technology the Kaldnes Moving Bed™ bio film process has been designed specifically to create the most effective environment for the nitrification process to take place. The media is engineered in a wheel shape and is slightly positively buoyant, allowing a small amount of water flow created by adding air to the process) to circulate the media throughout the vessel.

Oxygen and food (ammonia and nitrite) gives the bacteria the means to grow, whilst the Kaldnes media provides maximum surface area for the bacteria to colonise and produce bio film. It is this process, which removes harmful ammonia and nitrite from the water. As the Kaldnes media chaotically circulates within the bio tank, it causes old dead bacteria/bio film on the outside, to be removed making space for new younger heavier feeding bacteria/bio film to colonise. Within the wheel, is a protected surface, which enables colonies of bacteria to naturally follow their life cycle, maturing and dying, in turn fuelling the latter stages of nitrification conversion process. It also assists in the breakdown of any small particles passing through from the mechanical stage. Therefore, the Kaldnes media maintains both a young biofilm & a maturing bio film providing a more consistent filter performance, whilst improving water quality, encouraging healthier Koi and aiding in reducing green water and blanket weed. Due to chaotic movement of Kaldnes K1 media, the process is self-cleaning and requires no maintenance. This allows the filter to reach optimum effectiveness without the disturbance of periodic maintenance, avoiding unnecessary loss of bacteria within the filter preventing high levels of ammonia and nitrite within the water. The other major benefit of Kaldnes K1 media is the huge 'active' surface area available for the bacteria to grow on compared to other types of media. This feature allows for smaller filter design, e.g. the Nexus, whilst providing increased biological efficiency.

How it all works

Maturing the Kaldnes bio-media is important. The maturing process needs monitoring closely to ensure that levels of pH, ammonia and nitrite are within acceptable parameters for your fish. Usually, within 2 - 10 weeks the filter will be effective and the parameters should be within

